



Monogram Wine Vault  
Owner's Manual



# TABLE OF CONTENTS

|  |        |
|--|--------|
| Important Safety Information .....                 | 4, 5   |
| A Quick Tour of Your Wine Vault .....              | 6, 7   |
| The Cellar Management System .....                 | 8–11   |
| Key Parts and Controls .....                       | 9      |
| Key Areas of the Cellar Management System .....    | 10     |
| Tips for Stocking Your Cellar the First Time ..... | 11     |
| The Cooling System .....                           | 12–17  |
| Lockable Entry Door .....                          | 18     |
| Redwood Wine Racks .....                           | 19–21  |
| Interior Lighting System .....                     | 22, 23 |
| Care and Cleaning .....                            | 24–27  |
| Troubleshooting .....                              | 28–31  |
| Consumer Services .....                            | 32     |
| Warranty .....                                     | 33–35  |
| Appendix .....                                     | 36–39  |
| Common Wine Terms .....                            | 36, 37 |
| The Perfect Serve .....                            | 38, 39 |

## Acquaint Yourself With Your New Wine Vault

Read this manual carefully. It is intended to help you operate and maintain your new wine vault properly and enjoy the many unique features that your wine vault offers. Keep it handy for answers to your questions. If you don't understand something or need more help, there is a list of toll-free consumer service numbers included in the back section of this manual.

## Save Time and Money

Before requesting service, please refer to the Troubleshooting section in this manual. It lists solutions to common questions and problems that you can correct yourself.

## Write Down the Model and Serial Numbers

You will find them on the access cover plate on the inside wall of the wine vault, to the bottom right of the door.

Model number \_\_\_\_\_

Serial number \_\_\_\_\_

Use these numbers in any correspondence or service calls concerning your wine vault.

## *Well done!*

*Superb wines deserve superb care. You've wisely chosen the Monogram® Wine Vault to protect and showcase your collection.*

*This spacious, self-contained storage unit is designed to help you protect your precious wine collection as it matures. From consistent temperatures to total inventory control, the Monogram Wine Vault manages your collection as if it were your personal sommelier. The Monogram Wine Vault's elegant design cradles and showcases your precious inventory and creates a focal point for the enjoyment of your wine collection.*



# IMPORTANT SAFETY INFORMATION

## **WARNING!**

When using electrical appliances, basic safety precautions should be followed, including the following:

- Use this wine vault for its intended purpose as described in the Owner's Manual.
- This wine vault must be properly installed in accordance with the Installation Instructions before it is used.
- Do not install the wine vault outdoors or expose it to outdoor conditions.
- **ATTENTION CONSUMER!** This unit is designed for storing and cooling wine. Do not store perishable foods in this unit.
- This wine vault is not a storm shelter. Do not seek shelter in the wine vault during inclement weather or during seismic activity.
- Allow 4 feet clearance in front of the wine vault cooling unit to allow for proper air circulation.
- Do not allow children to climb, stand or hang on the racks in the wine vault. They could seriously injure themselves and damage the wine vault.
- Do not store or use gasoline or other flammable vapors and liquids in the vicinity of this or any other appliance.
- Keep fingers out of "pinch point" areas around the door. Be careful closing the door when children are in the area.
- A qualified individual must perform any service to the wine vault. The warranty may be voided if a non-qualified individual services the wine vault.
- Do not put anything near or in front of the door that could block the door to the wine vault and possibly trap one inside.
- If standing water is apparent, turn off the power at the main breaker before approaching the wine vault.
- Do not walk or store items on the roof of the wine vault. It is not designed to carry additional weight.
- Before replacing a burned-out light bulb, turn the motion sensor to off. See the *Interior Lighting System* section.

**CAUTION:** Light bulbs may be hot. (A burned-out light bulb may break when being replaced.)

 **CAUTION:** The scanner contains a Class II laser. Avoid long term viewing of direct laser light. Looking directly into laser for extended periods of time may cause eye damage.

# IMPORTANT SAFETY INFORMATION

## **⚠ WARNING!**

*When using electrical appliances, basic safety precautions should be followed, including the following:*

## HOW TO CONNECT ELECTRICITY

**Do not, under any circumstances, cut or remove the third (ground) prong from the power cord. For personal safety, this appliance must be properly grounded.**

The power cord of this appliance is equipped with a twist-lock 3-prong (grounding) plug which mates with a specialized 3-prong (grounding) wall outlet to minimize the possibility of electric shock hazard from this appliance.

Have the wall outlet and circuit checked by a qualified electrician to make sure the outlet is properly grounded.

Where a standard 2-prong wall outlet is encountered, it is your personal responsibility and obligation to have it replaced with a properly grounded 3-prong twist-lock wall outlet.

Do not use a GFI (Ground Fault Interruptor) for the wine vault outlet.

This unit must be plugged into a dedicated **30-Amp**, 120 VAC circuit.

**DO NOT USE A PLUG DESIGNED FOR A 15-AMP or 20-AMP CIRCUIT.**

**DO NOT USE AN ADAPTER PLUG TO CONNECT THE COOLING UNIT TO A 2-PRONG OUTLET.**

**DO NOT USE AN EXTENSION CORD WITH THIS APPLIANCE.**

**DO NOT BLOCK ACCESS TO THE ELECTRICAL OUTLET.**

Never unplug an appliance by pulling on the power cord. Always grip the plug firmly, turn counterclockwise to unlock, and then pull straight out from the outlet.

Immediately repair or replace all power cords that have become frayed or otherwise damaged. Do not use a cord that shows cracks or abrasion damage along its length or at either end.

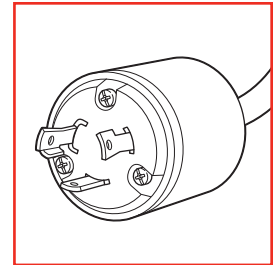

*READ AND FOLLOW THIS SAFETY INFORMATION CAREFULLY.*

**SAVE THESE INSTRUCTIONS**

# A QUICK TOUR OF YOUR WINE VAULT

The illustrations below highlight many of the most important components of your Monogram Wine Vault. Please take time to familiarize yourself with these components; they will be referenced throughout this manual.

## Exterior Features

Stainless steel exterior panels

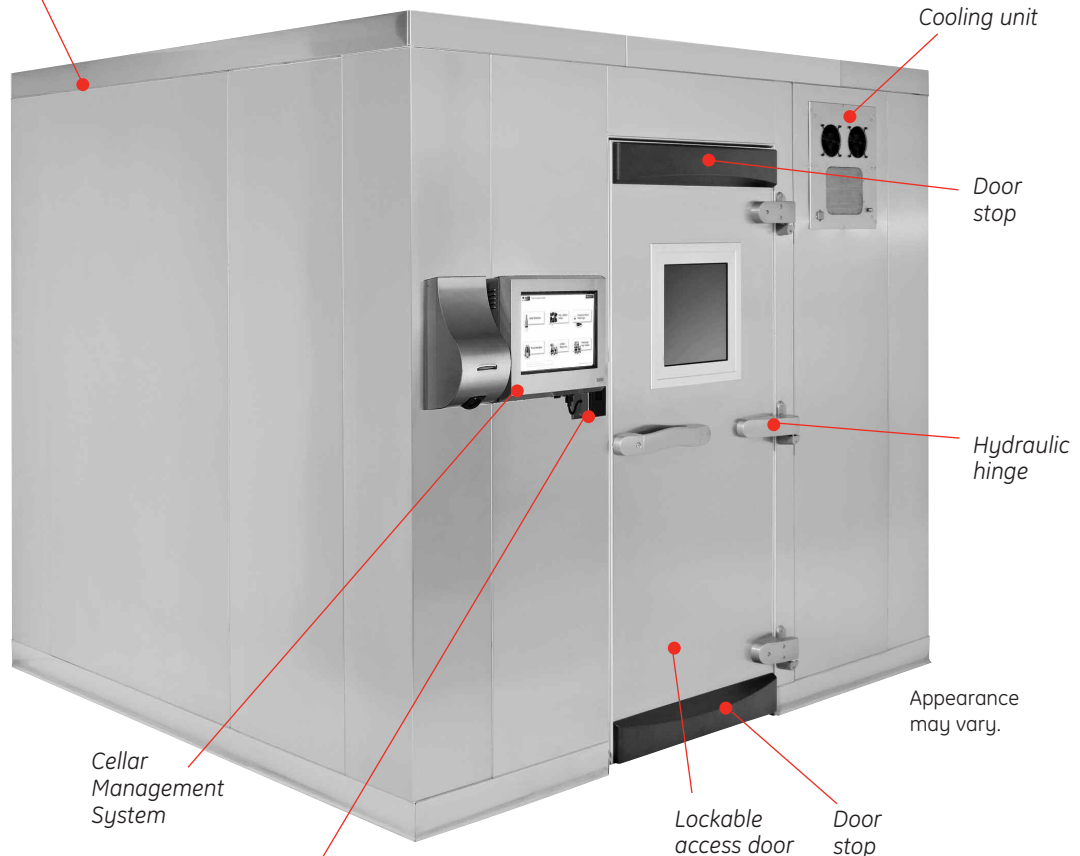

**Digital Temperature Display** – Displays the current air temperature within the wine vault.

**Lighting Control** – Switches the wine vault ceiling lighting on and off. Switches the interior rope display lighting on or off (in the ZWVT1000SR model only).

OR

**Internal Outlet Control** – This switch controls the internal outlet that is located to the side of the door jamb.





**Interior Features – Tasting Racking System (model ZWVT1000SR)**

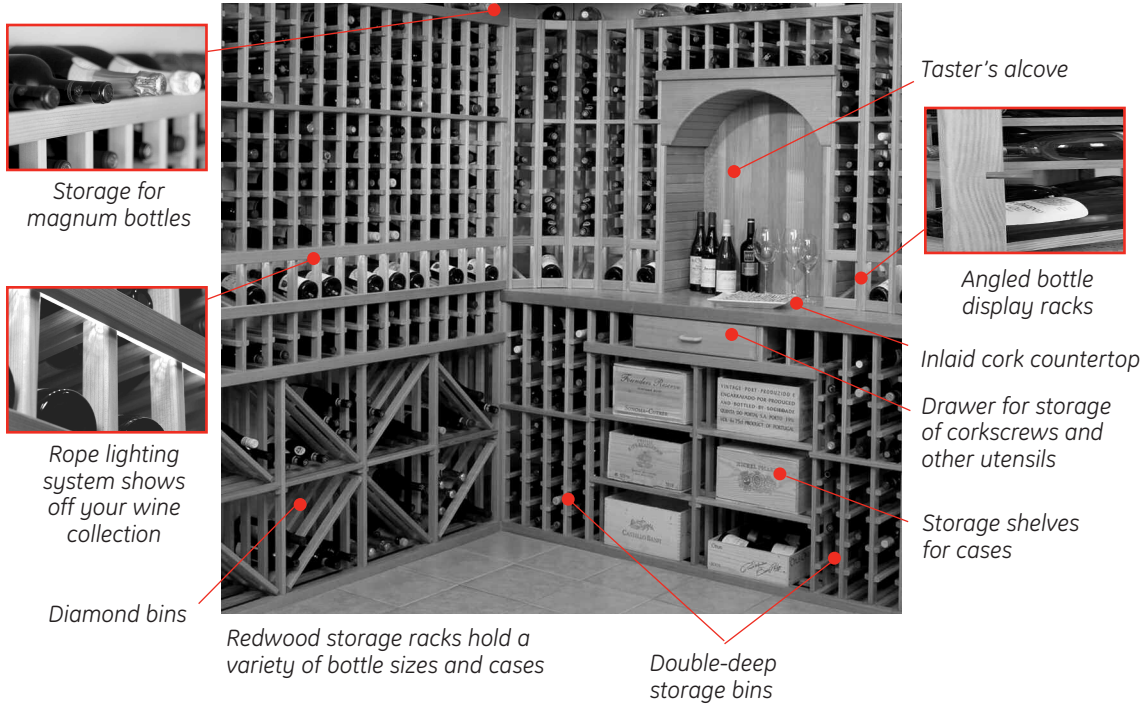

**Interior Features – Storage Racking System (model ZWVS1000SR)**

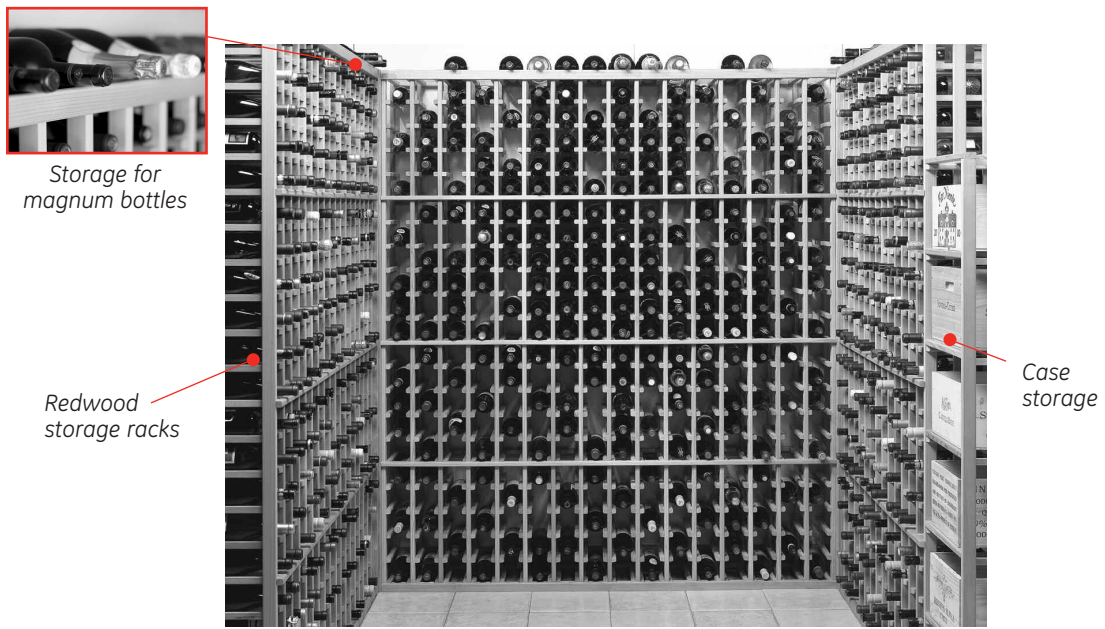

# THE CELLAR MANAGEMENT SYSTEM

The GE Monogram® Cellar Management System is like your own personal wine expert, always available to help you keep your wine collection in peak form and choose the perfect wine for your enjoyment.

The system comes preprogrammed with information about thousands of wines. It allows you to track individual bottles by country, appellation, producer, varietal, designation, vintage, price and maturity. You can easily enter information about wines that have not been preprogrammed into the system, such as local favorites. And, the Cellar Management System will track wines that have reached maturity and are ready to be enjoyed. The following section provides you with a brief overview of the many functions of the Cellar Management System. For detailed information and instructions, refer to the Cellar Management System Setup and Operation Guide.



Cellar Management System

HELP

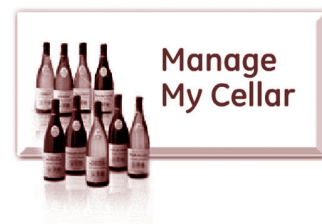

Your bottle queue is empty.

©2006 General Electric Company and its licensors.





## Key Parts and Controls



- 1 Color Touch Screen Console** – Shows Cellar Management System data on an easy-to-read color screen. Touch screen function simplifies interaction with the system.
- 2 Thermal Label Printer** – Thermal printer prints barcoded inventory labels with important information for each bottle to allow easy tracking.
- 3 Scanner** – Scan bottles as they are removed to take them out of inventory.
- 4 Power Cord** – Connects to the wine vault power system.
- 5 Ethernet Network Port** – Connects to your home computer network.
- 6 External USB Port** – Used for backup purposes.
- 7 Cellar Management System Certified Service Technician Lock** – Do not attempt to open this lock or service this computer; it will void the warranty. Call 1.877.234.WINE (877.234.9463) for service.

# THE CELLAR MANAGEMENT SYSTEM

**Note:** The touch screen features a screen saver mode to conserve power and maximize system life. The touch screen screen saver activates after six minutes of no activity. When the screen saver is on, the scanner will be deactivated. To activate the touch screen and scanner, touch the touch screen; they will activate within 5 seconds.

## Be sure to familiarize yourself with key areas of your Cellar Management System.

Taking time to review the key functions and components of the Cellar Management System before you begin will help you make use of many time-saving functions.

### Add Bottles

- The *Bottle Lookup* in the *Add Bottles* area is the easiest way to add a bottle. Enter any information from the wine label to see all possible matches from a list of 20,000 wines. Your selection is entered into the *Add Bottles* fields for you.
- The *Recent Bottles* list displays the last 30 bottles entered into your system. Select a bottle from the list to copy the information to the *Add Bottles* fields.
- Enter the country and appellation first and your system will narrow your choices on the *Add Bottles* screen.

### Find Bottles

- The *Bottle Lookup* tool in *Find Bottles* is the quickest way to locate a bottle. Enter any information from the wine label to see all of the possible matches in your inventory.
  - \* Also, search by keyword or wine details to find bottles in your cellar with ease.

### Remove Bottles

- Remove bottles from your cellar in seconds by using the bottle scanner.

## Manage My Cellar

### My Cellar View

- View color-coded cellar diagrams indicating bottles by color and maturity.

### Back Up Your Wine Data

- Back up your wine data each week in the *Manage My Cellar* area of your software. By backing up this information, you ensure that you always have an additional, current copy of your wine data.

**Reminder:** If you have high-speed Internet access at your cellar and register your wine vault at [www.monogram.com.wine](http://www.monogram.com.wine), GE will also save a copy of your wine data weekly to the GE central server.

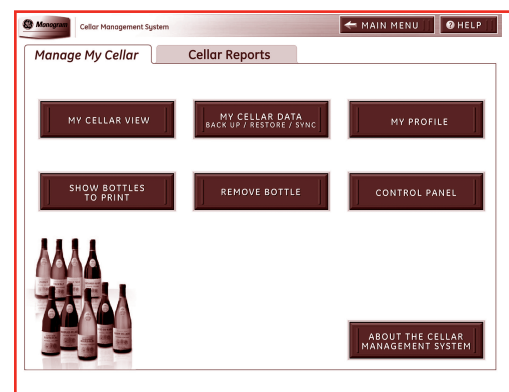

## My Profile

- View your profile information, including confirmation of online access.

## My Preferences

- Change the style of your printed bottle label or software preferences by going to the *Manage My Cellar* area of your software.

## Software Security Preference

- The *Software Security* button located under *My Profile* in the *Manage My Cellar* section allows you to password-protect your software according to your preferences.



## Control Panel

- The *Control Panel* button located on the *Manage My Cellar* screen leads to the *Restart*, *Shutdown* and *System Status* options.

## Turning Off Your Machine

### To Shut Down Your Machine

If you need to unplug or turn off your Cellar Management System, use the *Shutdown CMS* option to safely shut down the software.

1. Select the *Shutdown CMS* button located in the *Control Panel* area of *Manage My Cellar*. Your software will automatically shut down. Next, unplug your Cellar Management System. To turn the CMS on again, plug it in.

### Restart Instructions

If the touch screen does not respond after 45–60 seconds, the system may need to be restarted.

### To Restart:

1. Select the *Restart CMS* button located in the *Control Panel* area of *Manage My Cellar*. The *Restart CMS* function resets your software in the event of an error or data problems (bottles not displaying in the cellar view). Your software will automatically shut down and restart upon your selecting this option.



## Tips for Stocking Your Cellar the First Time

After becoming familiar with your cellar system, you'll want to focus on stocking your cellar as efficiently as possible. Here are some tips to help you save time as you input bottle information into your system and place bottles into your cellar.

### Plan Ahead Before Stocking or Inventorying Your Cellar

- Organize like bottles before adding them to your cellar. Enter the bottle information once, and indicate the number of bottles on the *Add Bottles* screen.
- Arrange your work area to make bottles, bottle tags and empty boxes easily accessible. Eliminate multiple trips to the cellar by placing tagged bottles in a box for transfer.

## THE COOLING SYSTEM

The cooling unit system is designed to maintain the set temperature under average ambient conditions. Most wines will be stored in conditions of 50% to 70% humidity. The unit will not remove excess humidity from the wine vault. In a humid climate, you may need to find a means to remove humidity, such as a dehumidifier. In a dry climate, you may need to find a means to add humidity, such as a fountain. The cooling system gently cools the wine rather than quick chilling. Allow 48–120 hours for temperatures to stabilize. This time may vary depending on starting temperature and quantity of wine bottles added initially.

### Temperature Setting

The unit can be set at any temperature within the acceptable wine-aging range of 50°F to 70°F ambient temperature. It is designed to cool 30°F cooler than the ambient temperature of the exterior room, which should stay within the range of 45°F to 85°F.

### Drain Line Connection

All units are equipped with a drain port for additional removal of excess condensation in *high humidity areas*. A drain line may need to be attached to allow the condensation to drain. A means to catch the condensation will need to be placed below the drain line.

A drain line may be ordered by calling the Monogram Wine Vault Line, 877.234.WINE (877.234.9463). Order part # WR02X12181.

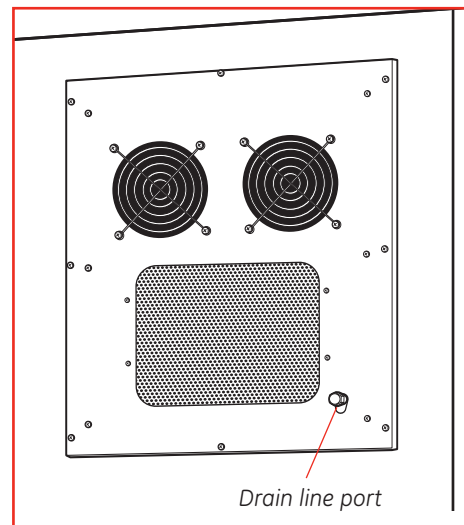

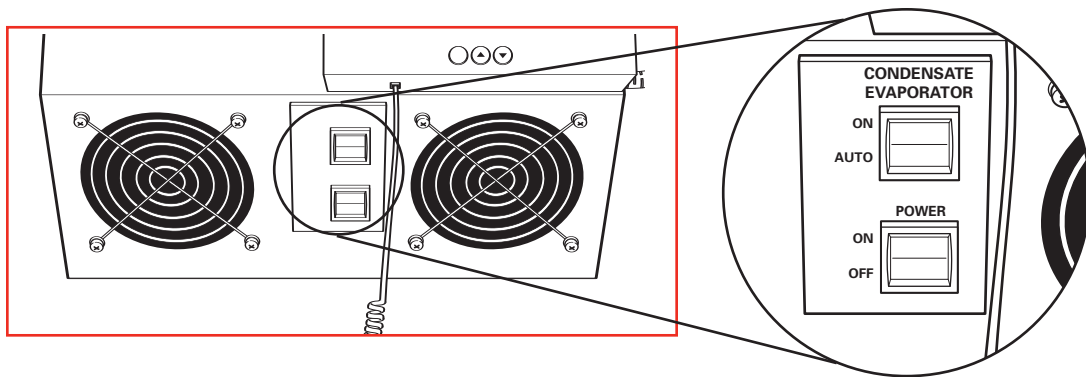

## Power Switch

The Power Switch is the ON/OFF switch for the cooling system. When first turning the unit on, there is a safety delay of 5 minutes. On the temperature display, a red LED light will light up beside WINE to indicate that start-up has been initiated and that the thermostat is reading the liquid temperature. After 5 minutes, the red LED light beside ON will light up.

## Condensate Evaporator Switch

The ON position of the Condensate Evaporator Switch activates the heating element whenever water is present in the evaporator pan. The AUTO position of the Condensate Evaporator Switch activates the heating element at regular intervals to remove excess water from the evaporator pan, as needed.

In most environments, the Condensate Evaporator Switch should be kept in the ON position. If your wine vault is located in a dry climate, excess water may not accumulate in the evaporator pan. In this case, turn the Condensate Evaporator Switch to the AUTO setting to save electricity.

# THE COOLING SYSTEM

## Operating the Cooling System

The unit is set to 55°F at the factory. The temperature of wine caves in Europe is typically 55°F, the temperature wine collectors strive to match.

Pressing the SET button will display the set temperature. To increase or decrease the set temperature, press and hold the SET button while pressing the UP arrow or DOWN arrow until the desired temperature is displayed.

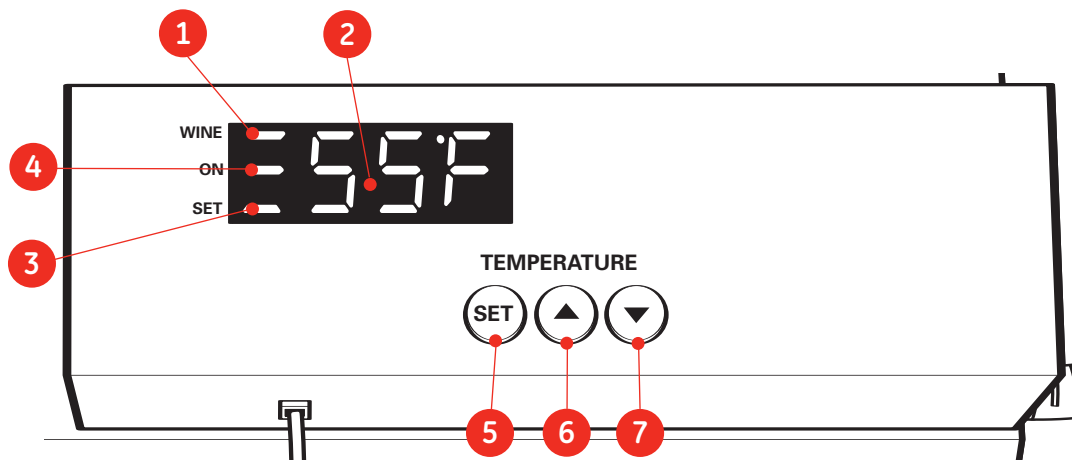

- 1 Wine Temperature Indicator** – The red LED lamp beside WINE will light up when the thermostat is reading the liquid temperature.
- 2 Wine Temperature Reading** – The temperature of the water in the bottle as detected by the probe.
- 3 Temperature SET Indicator** – A red LED lamp beside SET will light up while you are adjusting the temperature.
- 4 Unit ON Indicator** – A red LED lamp beside ON will light up every time the unit turns on to run a cooling cycle.
- 5 SET Button** – Use in conjunction with the UP and DOWN arrows to set the desired temperature .
- 6 UP Arrow Button** – Press the UP arrow button while pressing and holding the SET button to INCREASE the set temperature.
- 7 DOWN Arrow Button** – Press the DOWN arrow button while pressing and holding the SET button to DECREASE the set temperature.



## Additional Cooling System Features

To ensure efficient operation and a long service life, the cooling system also includes:

- A built-in Defrost Cycle, which shuts the unit off periodically in order to prevent frost buildup.
- Heavy-duty circuitry to resist power surges.

# THE COOLING SYSTEM

## Liquid Temperature Display

The cooling unit temperature display indicates the **liquid temperature** in the wine vault, rather than the **air temperature** in the wine vault. This ensures optimal wine temperature preservation and allows for temperature adjustment between 45°F and 85°F.

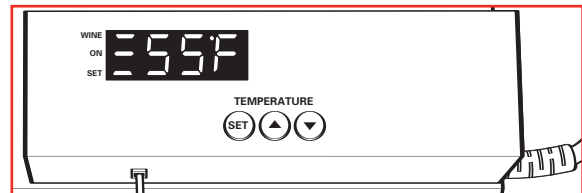

The liquid thermostat is equipped with a Self-Calibrating Probe, which contains a sensor that communicates with the thermostat to ensure a consistent temperature.

### To use the liquid thermostat:

**Step 1:** Fill a clean, empty 750 ml wine bottle 3/4 full with room-temperature tap water.

**Step 2:** Place the bottle probe securely into the bottle.

**Step 3:** Place the bottle with probe in a central location *out of the direct path of the air coming from the cooling unit* (see recommended location) in your wine vault. Avoid stretching the probe cord. It may become disconnected, resulting in the unit not working properly.

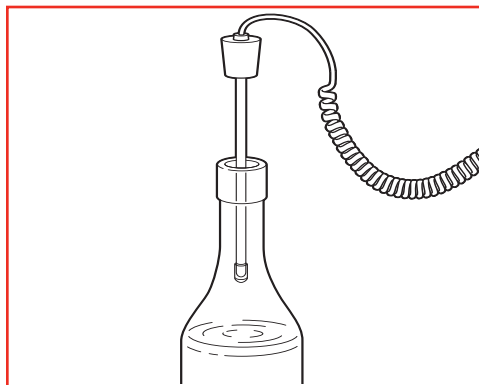

Installing the probe in a bottle

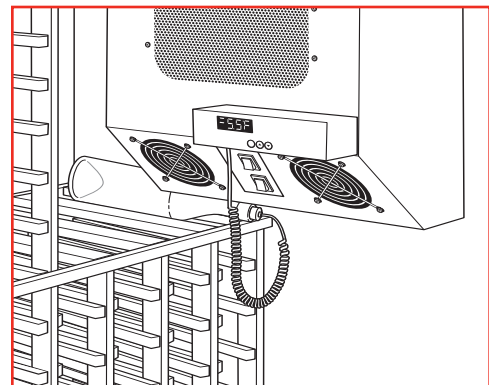

Recommended location for probe

## Vault Room Temperature Display

The wine vault features a digital temperature display on the exterior of the vault, next to the door. This digital display shows the wine vault *air temperature* surrounding the bottles. The ambient air temperature is monitored by the dry probe in the wine vault.

Weave the dry probe along the back of the racks so that the probe end is located about twelve slots from the front wall. This placement will provide a central temperature reading of the wine vault's interior air temperature.

Vault room air temperature display

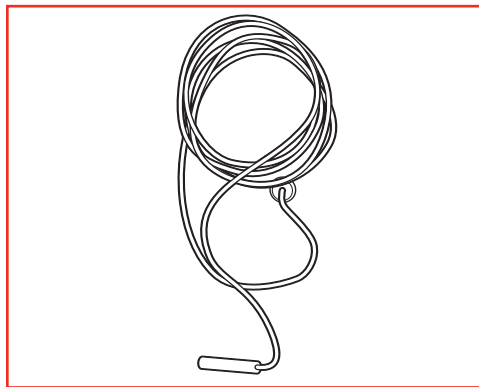
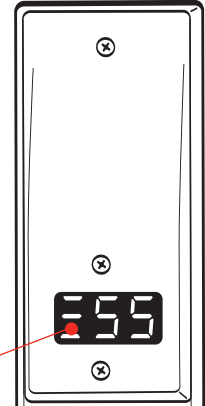

Uncoil the dry probe...

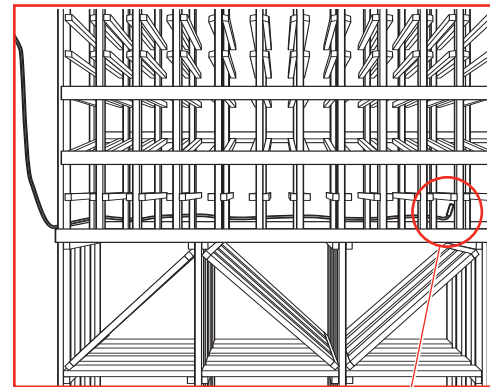

...and weave it behind the racks to about 12 slots from the front wall.

## Variance Between the Vault Room Temperature and the Liquid Temperature Display

The temperatures shown in the digital temperature display and liquid probe thermostat may differ from one another up to 10°F. The air temperature will vary due to the length and frequency of door openings. Always refer to the liquid probe temperature readout on the cooling unit for an accurate wine temperature reading.

**NOTE: The air temperature will be cooler than the liquid temperature until the optimum temperature balance is achieved.**

## LOCKABLE ENTRY DOOR

Your GE Monogram Wine Vault features a lockable, auto-closing door that is designed to protect your wine collection from unauthorized access.

**WARNING!** Be careful closing and opening the door when children are in the area. Keep fingers out of "pinch point" areas around the door.

### Interior Door Release

An inside safety door release will prevent anyone from being locked inside the wine vault. Two keys are included with your wine vault.

Additional keys (part # WR05X10020) may be ordered by calling the Monogram Wine Vault Line, 877.234.WINE (877.234.9463) OR by contacting your local dealer. Always store keys in a safe place, out of the reach of children.

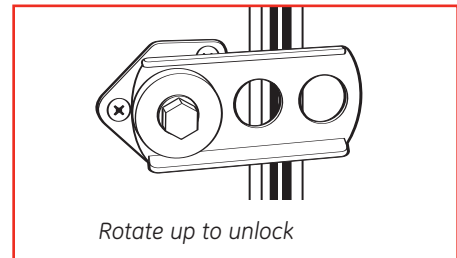

# REDWOOD WINE RACKS

The premium Heart of Redwood racks by Apex are sturdy and naturally moisture-resistant, with the natural beauty of the finest select redwood. These racks are designed to provide optimal air circulation while providing an attractive and functional environment for accommodating various sized bottles.

There are two types of racking systems:

*Storage (model ZWVS1000SR) and*

*Tasting (model ZWVT1000SR).*

Both racking systems are labeled to help identify the location of your wine bottle.

**Note:** The bin location labels are organized with letters indicating the row and numbers on every fifth column.

**Do not apply a stain or wood preservative to the redwood racks.** The racks must be left unfinished and unpolished to enable them to breath and flex. In addition, stain may cause an odor within the wine vault.

The natural redwood will darken in color as it ages. A new unit will have lighter colored racks; however, within a few months, the redwood racks will begin to darken to their peak dark patina.

## Storage Racks (model ZWVS1000SR)

Storage Racks are designed to store individual bottles and cases of wine and feature different sections to accommodate a variety of bottle sizes.

| Storage Area Type                     | Qty. |
|---------------------------------------|------|
| Magnum Bottle (1.5 L)                 | 46   |
| Single Bottle (750mL)                 | 966  |
| Bulk or Case Bins (15 750 mL Bottles) | 60   |

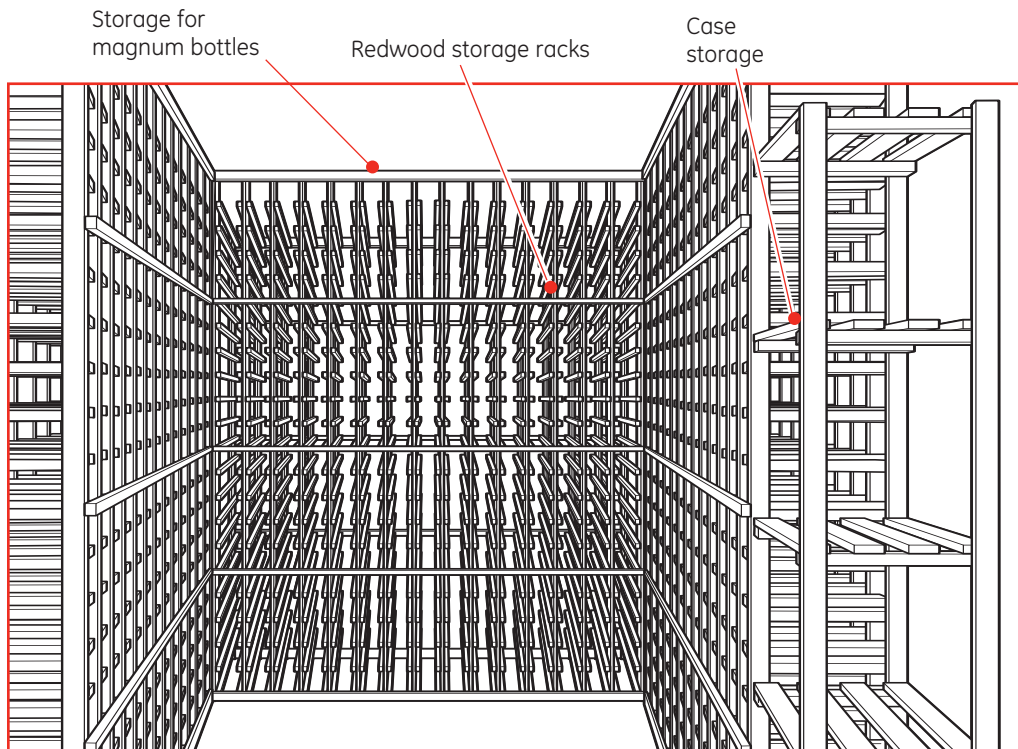

# REDWOOD WINE RACKS

## Tasting Racks (model ZWVT1000SR)

The Tasting Rack System offers attractive racks with several unique display and storage features.

| Storage Area Type                    | Qty. |
|--------------------------------------|------|
| Magnum Bottle (1.5 L)                | 41   |
| Single Bottle (750 mL)               | 396  |
| Display Bottle (750 mL)              | 38   |
| Double-Deep Single Bottle (750 mL)   | 152  |
| Diamond Bins (14 750 mL Bottles)     | 224  |
| Double-Deep Bins (15 750 mL Bottles) | 180  |

## Diamond Bins

Convenient Diamond Bins are designed to accommodate most bottle sizes and also feature removable slats to allow room for storing cases. Simply slide the angled divider slat out to store cases; slide it back in for storing bottles of virtually any size.

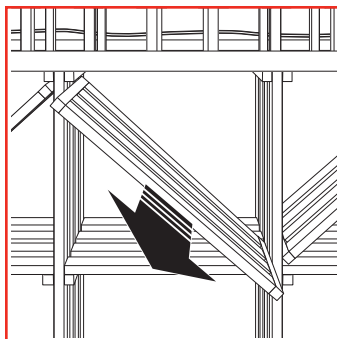

Remove the angled divider slat for storing cases.

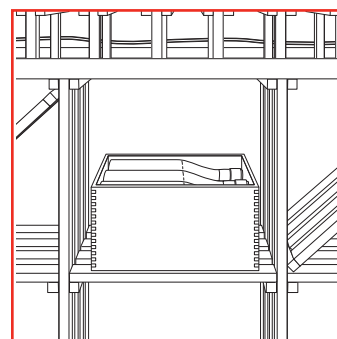



## Taster's Alcove

The Taster's Alcove provides an impressive setting for sampling or sharing a glass with fellow wine aficionados. Unique features include:

- Angled bottle display racks hold the bottle at a 12° angle to showcase your favorite bottles of wine while keeping the cork moist (assuming that the wine is in good condition and at a proper fill level). This 12° angle also helps disperse sediment.
- An elegant inlaid cork countertop.
- A removable storage drawer.
- Six display and storage shelves designed to hold a case or up to 15 bottles each.
- Double-deep bottle storage in the single wine bottle bins under the countertop on the entire back wall.

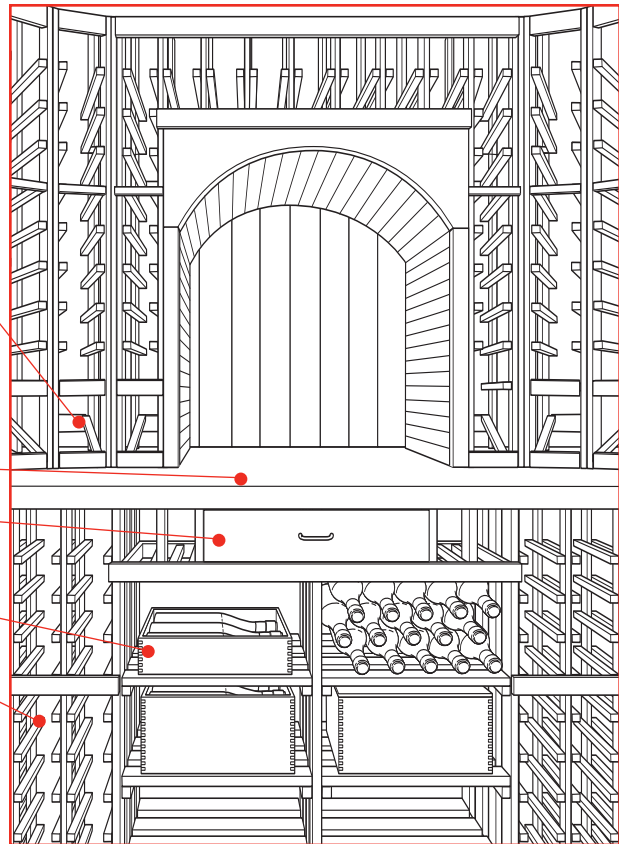

### To remove the storage drawer:

1. Pull the drawer out to the STOP position.
2. Push the tab on the right drawer guide down while pulling the tab on the left guide up, and pull the drawer out.

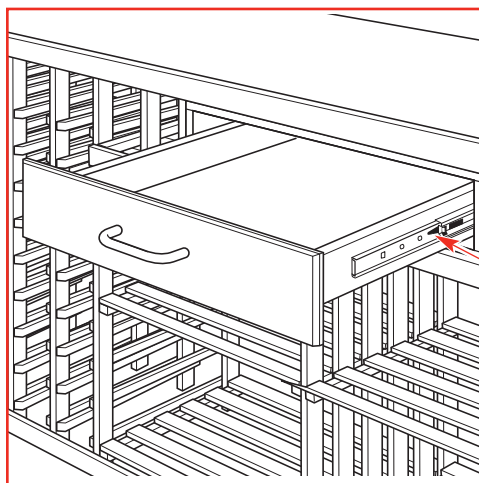

Tab (push tab down on right drawer guide; pull tab up on left drawer guide)

### To replace the storage drawer:

1. Push the drawer slide arm back into the unit.
2. Pull the small slide subassembly completely forward.
3. Insert the sides of the drawer back into the guides.
4. Push until the tabs lock into place.

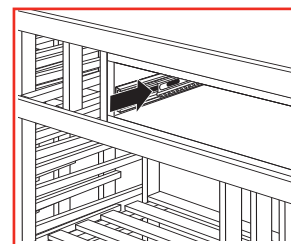

To replace, push drawer slide arm back into unit.

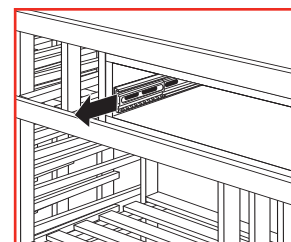

Pull small slide sub assembly completely forward.

# INTERIOR LIGHTING SYSTEM

Your wine vault features two separate interior illumination systems:

A *Ceiling Lighting system* with low-voltage halogen lamps which provide general lighting in the interior of the wine vault.

A *manually activated Rope Lighting system* (on models with Tasting Rack ZWVT1000SR only) is concealed behind the rack fronts to provide indirect lighting designed to enhance the beauty of your wine collection.

## Ceiling Lighting

The interior ceiling halogen lamps make it easy to view your wine collection. The exterior rocker switch allows you to illuminate the wine vault before entering. Remember to turn off the light when exiting the wine vault. If the lights remain on for an extended period of time, they may increase the overall wine vault temperature.



On/Off switch for interior ceiling lighting

## Rope Lighting System (with Tasting Rack model ZWVT1000SR only)

The rope lighting system is controlled with a rocker switch on the exterior wall of the wine vault, next to the door. The rope lights plug into an outlet on the interior of the wine vault, just inside the door.

### To Replace a Strand:

The bulbs within the rope light strands are designed for a long service life and will likely never need replacing. However, if a bulb or bulbs within a strand burn out or are damaged, it is necessary to replace the entire strand containing the defective bulb(s). Contact your dealer or call the Monogram Wine Vault Line at 877.234.WINE (874.234.9463) to schedule service.



*On/Off switch  
for interior rope  
lighting*

# CARE AND CLEANING

Your GE Monogram® Wine Vault is designed to give you many years of service with minimal maintenance. To help ensure the continued beauty and durability of your wine vault, please follow the Care and Cleaning instructions at the recommended intervals.

**IMPORTANT:** In the event of a power failure, you can maintain interior temperature longer by keeping the door closed. Open the door only when necessary to avoid the loss of cold air.

## Recommended Cleaning Intervals for Key Components

The recommended cleaning intervals for certain components will vary from one location to another, due to factors such as humidity or dust. Use the chart below as a guideline for cleaning intervals; you may need to adjust the intervals depending on your installation location. Refer to the following instructions for specific details on proper care and cleaning procedures.

| Environment               | Polish with Stainless Steel Magic® | Clean the drain line (if equipped) | Clean the liquid probe |
|---------------------------|------------------------------------|------------------------------------|------------------------|
| Basement or High Humidity | Monthly                            | Every 6 months                     | Every 6 months         |
| All Others                | Every other month                  |                                    |                        |

## Cleaning the Exterior of the Wine Vault

To preserve the fine finish, regularly polish the stainless steel exterior and handle with stainless steel cleaner and the Monogram polishing cloth. Stainless steel cleaner and the Monogram polishing cloths are available through the *GE Monogram Wine Vault Hotline*, 877.234.WINE (877.234.9463). For stainless steel cleaner, order part number WR97X10116. For the Monogram polishing cloth, order part number WR97X10117.

- To avoid scratching the fine finish of the stainless steel, wipe in the same direction as the grain when polishing or cleaning any stainless steel surface.
- **Never** use appliance wax or polish on the stainless steel.
- **Never** use scouring pads, powdered cleaners, bleach, or cleaners containing bleach because these products can scratch and damage the finish.
- Using the hose on your vacuum cleaner, remove any dust off the exterior cooling system vent every 6 months.

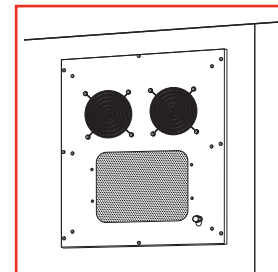

## Cleaning the Interior of the Wine Vault

The sealed system helps eliminate most airborne dust and contaminants when the wine vault is left unopened. Under normal use, cleaning the inside would consist of vacuuming the floor and the cooling system vent on the inside of the wine vault every six months.

### Maintaining the Redwood Racks

To clean up spills, use a damp sponge with warm water and rinse thoroughly; then wipe dry. Spilled wine may stain the redwood racks. Normal drops of wine add character to the wine vault. To remove small stains, use a fine grit sanding sponge (150 grit is recommended).

With normal usage, small marks or scratches may become visible on the natural redwood racks. This gives your racks the warm character of the world's finest wine cellars.

**The racks are unfinished to allow them to breath and flex in the refrigerated environment.**

- Do not apply wood stain or wood preservative to the redwood racks.
- Do not apply polish or wax to the redwood racks.

### Cleaning the Interior Walls

To clean up spills or residue on the interior walls and behind the racks use a long handled scrub brush or sponge with warm water and baking soda solution – about a tablespoon (15 ml) of baking soda to 1 quart (1 liter) of water. This both cleans and neutralizes odors. Thoroughly rinse and wipe dry.

### Cleaning the Inlaid Cork Countertop (Tasting Rack model ZWVS1000SR only)

For regular cleaning, dampen a sponge with warm water. For a stronger cleaner, make a solution consisting of 1 part vinegar to 4 parts warm water.

- Do not use scouring pads, powdered cleaners, bleach, or cleaners containing bleach because these products can damage the countertop.

# CARE AND CLEANING

## Cleaning the Interior of the Wine Vault

### Cleaning the Liquid Probe

**Step 1** Check the water level in the liquid probe every 6 months. Make sure that it is approximately 3/4 full.

**Step 2** Use warm water and baking soda solution† to clean the probe and wine bottle. This both cleans and neutralizes odors.

**Step 3** Rinse thoroughly and wipe dry.

**NOTE:** Ensure that all wine residues are removed from the bottle used for the probe.

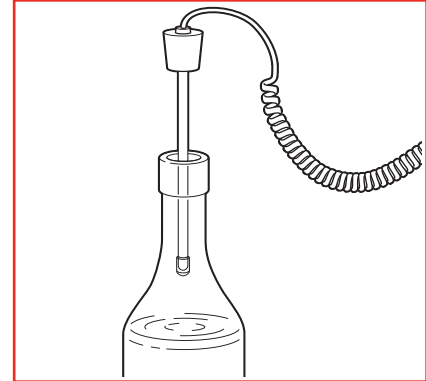

### Cleaning the Door Gasket

**Step 1** The vinyl gasket may be cleaned with mild soap and water, a baking soda solution or a mild scouring powder.

**Step 2** Rinse well.

**Step 3** After cleaning the door gasket, apply a thin layer of paraffin wax or petroleum jelly to the door gasket at the hinge. This helps keep the gasket from sticking and bending out of shape.

### Cleaning the Drain Port

In the event that a drain line is attached to the drain port of your cooling unit, follow the cleaning instructions below:

**Step 1** Remove the drain line to check for clogs or debris every 6 months.

**Step 2** Use warm water and baking soda solution† to clean the drain line and drain bucket. This both cleans and neutralizes odors.

**Step 3** Rinse thoroughly and wipe dry.

† **Note:** The recommended baking soda solution for cleaning the probe and drain port is approximately one tablespoon (15 ml) of baking soda to 1 quart (1 liter) of water.

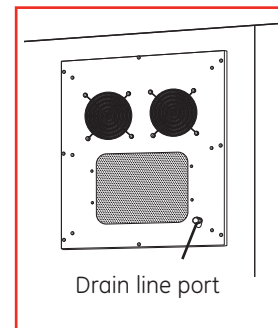



## Replacing Halogen Bulbs

The halogen bulbs used in the ceiling lighting of the wine vault will provide years of service under normal operating conditions. However, should a bulb burn out, refer to the following instructions to replace the bulb.

### **WARNING!**

**Halogen bulbs generate intense heat. Be certain power is off and lamps have sufficient time to cool before attempting to replace.**

**Bulbs may break during replacement. Be careful when removing or installing bulbs.**

#### **To replace a halogen bulb:**

- Step 1** Set the motion sensor switch to OFF. To ensure sufficient illumination, it may be necessary to use an auxiliary light while replacing the bulb.
- Step 2** Twist the light shield counterclockwise to disengage the locking tabs, then pull straight down to remove.
- Step 3** Remove the burned out bulb by pulling it straight out and replace the bulb with a 12 VAC, G4 Base, Bi-Pin 10-watt maximum halogen bulb.
- Step 4** To reinstall the light shield, align the three tabs on the light shield with the slots in the light fixture. Twist the shield clockwise until the tabs lock in place.
- Step 5** Set the motion sensor switch to AUTO.

**To order replacement bulbs, call the Monogram Wine Vault Line at: 877.234.WINE (877.234.9463). The light bulb part number is WR02X12174.**

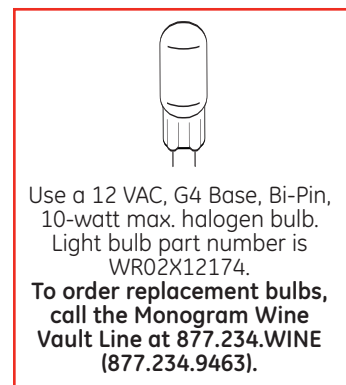
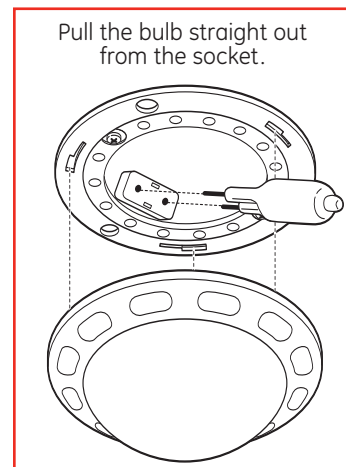
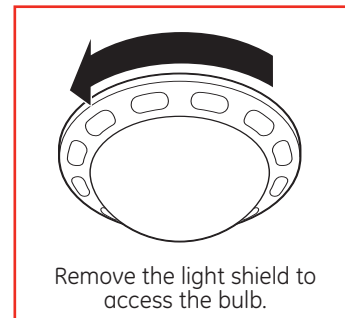

# TROUBLESHOOTING

## Normal Sounds You May Hear

| Sound               | Source  |
|---------------------|---|
| Continuous humming. | This is normal. The fan will make a humming sound when the cooling unit is operating. |
| Whirring sound.     | This is normal when the cooling unit first comes on and shuts off.                    |

## Ceiling Lighting

### Ceiling lights do not come on.

| Possible Cause                     | Recommended Solution  |
|------------------------------------|---|
| Light bulb(s) need to be replaced. | See <i>Care and Cleaning</i> for instructions on replacing the bulbs. |

## Rope Lighting

### Rope lights do not come on (ZWVT1000SR models only).

| Possible Cause                       | Recommended Solution   |
|--------------------------------------|--|
| Controls are set to OFF.             | Press the On/Off switch located outside, near the door.                      |
| The rope lights have been unplugged. | Check the lower plug located on the inside of the wine vault, near the door. |

### One or more strands of the rope lights do not work (ZWVT1000SR models only).

| Possible Cause                    | Recommended Solution  |
|-----------------------------------|---|
| A strand has become disconnected. | Check the connectors on both ends of the unlit strands to make sure that they are connected properly. |



## Redwood Racks

### Racks show nicks, scrapes, or dents.

| Possible Cause  | Recommended Solution  |
|-----------------|---|
| This is normal. | A well-used wine vault will eventually gain the appearance of a beautifully aged cellar. See <i>Cleaning the Interior of the Wine Vault</i> . |

### Bottle fits loosely in rack.

| Possible Cause                  | Recommended Solution   |
|---------------------------------|--|
| Odd-shaped or odd-sized bottle. | Rotate the bottle.<br><br>See <i>The Cellar Management System</i> for suggestions on bottle placement. |

### Racks appear light in color.

| Possible Cause  | Recommended Solution   |
|-----------------|--|
| This is normal. | Newly installed racks will be light at first. As they age, they will darken to their peak dark patina. |

## Entry Door

### Door will not close completely or does not latch.

| Possible Cause   | Recommended Solution  |
|--|---|
| Foreign object holding the door open.                  | Check doorway for debris and other obstructions.  |
| The door gasket may be out of position.                | Reposition the door gasket. Make sure it is clean and pliable. See <i>Cleaning the Interior of the Wine Vault</i> . |
| The interior door latch may be in the locked position. | Rotate the interior door latch so that the door will close.   |

# TROUBLESHOOTING

## Cooling System

### Cooling Unit does not operate.

| Possible Cause                         | Recommended Solution  |
|--|---|
| Power switch set to OFF.               | Set power switch on cooling unit to ON.   |
| Power cord unplugged.                  | Make sure that the Cooling Unit power cord is plugged into the grounded outlet.   |
| Blown fuse or tripped circuit breaker. | Replace the fuse or reset the circuit breaker.<br><i>IMPORTANT:</i> The unit must be plugged into a 30-amp, 110-volt circuit. |

### Wine Vault is too cold.

| Possible Cause                                      | Recommended Solution  |
|---|---|
| Thermostat not set correctly.                       | Adjust the thermostat on the cooling unit. Refer to the <i>Cooling System</i> section for details.          |
| Liquid probe in incorrect location or not connected | Make sure that the liquid probe is set up and positioned as described in the <i>Cooling System</i> section. |
| Exterior room temperature is below 45°F.            | Increase temperature of the exterior room to between 45°F and 85°F.   |

### Wine Vault is too warm.

| Possible Cause                                       | Recommended Solution  |
|--|---|
| Temperature control not set to cold enough.          | Adjust the thermostat and allow 48–120 hours for the unit reach the set temperature.                                      |
| Warm exterior room.                                  | Adjust the temperature in the exterior room to between 45°F and 85°F.   |
| Foreign object holding the door open.                | Check doorway for debris and other obstructions.  |
| Frequent door openings.                              | Minimize the length of time the door is left opened.  |
| Liquid probe in incorrect location or not connected. | Make sure that the liquid probe is set up and positioned as described in the <i>Cooling System</i> section.               |
| Object impeding airflow to the cooling unit.         | Move any object that may be blocking the airflow in front of the cooling unit on the inside or outside of the wine vault. |
| Warm wine bottles recently added to the wine vault.  | Allow 48–120 hours for the cooling unit to stabilize the temperature.   |



## Compressor motor operates for long periods.

| Possible Cause                                  | Recommended Solution   |
|---|--|
| This is normal.                                 | Allow 48–120 hours for the unit to reach the set temperature when first installed.             |
|   | The cooling unit will run often due to its gentle cooling operation.                           |
|   | Operation of the fan is normal, due to the large volume of interior space that must be cooled. |
| Frequent door openings.                         | Minimize the length of time the door is left opened.   |
| Temperature control set at the coldest setting. | Check the thermostat to make sure that the temperature is set at the desired setting.          |
| Foreign object holding the door open.           | Check doorway for debris and other obstructions.   |

## Moisture forms on the outside of the cooling unit.

| Possible Cause                                   | Recommended Solution  |
|--|---|
| Condensate Evaporator Switch set to AUTO or OFF. | Set the Condensate Evaporator Switch to ON. See the <i>Cooling System</i> section.                            |
| Extremely high humidity.                         | This is normal. Make sure that the Condensate Evaporator Switch is set to ON.                                 |
|  | Controlling humidity and temperature in the exterior room with air-conditioning may eliminate this condition. |

## CONSUMER SERVICES

*With the purchase of your new Monogram Wine Vault, receive the assurance that if you ever need information or assistance from GE, we will be there. All you have to do is call—toll-free!*

### Monogram Wine Vault Line

Whatever your question about your Monogram® Wine Vault, the Monogram Wine Vault Line is available to help. Your call—and your question—will be answered promptly and courteously. The Monogram Wine Vault Line customer service is open Monday through Friday, 8:30 A.M. to 11:00 P.M. ET, and Saturday and Sunday, 9:00 A.M. to 11:00 P.M. ET. Call 877.234.WINE (877.234.9463).

### In-Home Repair Service

Contact Monogram Wine Vault Line customer service or the dealer from which you purchased the Monogram Wine Vault for expert repair service, scheduled at a time that's convenient for you.

For repair service to the redwood wine racks ONLY after the one-year warranty period has ended, please contact APEX at 888-999-9749.

### For Customers With Special Needs...

Consumers with impaired hearing or speech who have access to a TDD may call 800.TDD.GEAC (800.833.4322) to request information or service.





# WARRANTY INFORMATION

## **YOUR MONOGRAM WINE VAULT WARRANTY**

***Staple sales slip or canceled check here. Proof of original purchase date is needed to obtain service under warranty.***

**Warrantor in USA: General Electric Company, Appliance Park, Louisville, KY 40225  
Should your product need service, during the warranty period or afterward, call the GE Monogram Wine Vault line at 877.234.WINE (877.234.9463).**

## **What is Covered For Products**

General Electric Company (“GE” or “we” or “us”) warrants the Monogram Wine Vault against defects in material or workmanship in the following manner:

### **GE MONOGRAM WINE VAULT WARRANTY**

GE provides a limited warranty on only three major components of your GE Monogram Wine Vault—the external shell, the cooling system, and the electronics products, as defined below. The terms of those limited warranties are set forth below. **NO OTHER ELEMENT OR COMPONENT OF THE GE MONOGRAM WINE VAULT IS COVERED BY A GE WARRANTY.**

This warranty is extended to the original purchaser and any successor owner for products purchased for ordinary home use in the 48 mainland states, Hawaii and Washington, D.C. In Alaska, the warranty is the same except that it is LIMITED because you must pay for the service technician’s travel costs to your home.

All in-warranty service will be provided by GE Factory Service Centers or by GE-authorized Customer Care servicers during normal working hours.

Defective parts may be replaced with new or rebuilt parts at our option.

### **EXTERNAL SHELL LIMITED WARRANTY**

For a period of one (1) year from the date of original installation in the original location in Your home, which must be done by a GE-authorized installer (the “Original Installation”), we will provide, free of charge, parts and service labor in your home to either repair or replace, at our option, the front and ceiling foamed-in-panels only and the interior painted surfaces of the external shell that are defective in material or workmanship under normal home residential use and service (a “Manufacturing Defect”).

### **COOLING SYSTEM LIMITED WARRANTY**

For one (1) year from the date of Original Installation, we will provide, free of charge, parts and service labor in your home to either repair or replace the cooling system, at our option, or any part of it that fails because of a Manufacturing Defect, *except that*, for repair or replacement of the compressor part only, the applicable warranty period shall be five (5) years from the Original Installation date, with service labor provided at Your expense after the first year of the warranty.

### **ELECTRONIC PRODUCTS LIMITED WARRANTY**

For one (1) year from the date of Original Installation, we will provide, free of charge, parts and service labor to either repair or replace, at our option, the electronic product (i.e., flat-screen monitor, CPU, printer, bar code reader, integrated casing) or any part of it that fails because of a Manufacturing Defect. Service may, at GE’s option, be provided in your home or by having you mail the electronic product in its original or equivalent packaging at our expense to a GE-authorized servicer.

## What Is Not Covered for Products

- Service trips to your home to teach you how to use the product.
- Damage to the product caused by accident, fire, floods, war or Acts of God.
- Failure of the product if it is used for other than its intended purpose or used commercially.
- Improper installation, delivery, or maintenance. If you have an installation problem, contact your dealer or installer. You are responsible for providing adequate ventilation, electrical, plumbing, Internet, telephone, and other connecting facilities, and their configurations.
- Warranty claims arising if and after the Wine Vault is moved from its original installed location.
- Replacement of the light bulbs.
- ALTERATION OF ANY SERIAL NUMBER OR RATING PLATE VOIDS WARRANTY.
- **INCIDENTAL OR CONSEQUENTIAL DAMAGE CAUSED BY POSSIBLE DEFECTS WITH THIS APPLIANCE INCLUDING, WITHOUT LIMITATION, LOSS OF WINE DUE TO SPOILAGE OR OTHERWISE.**
- Product damage after installation other than from a Manufacturing Defect.
- Cosmetic damage caused during delivery or installation.
- Misuse, abuse, negligence, commercial use, or modification of or to any part of the Product.
- Improper operation or maintenance, including connection to improper voltage supply.
- Damage from attempted repair by other than GE or GE-authorized servicers.
- Replacement of house fuses or resetting of circuit breakers.

**REPAIR OR REPLACEMENT AT GE'S OPTION AS PROVIDED UNDER THIS WARRANTY IS THE EXCLUSIVE REMEDY OF THE CONSUMER. GE SHALL NOT BE LIABLE FOR ANY INCIDENTAL OR CONSEQUENTIAL DAMAGES FOR BREACH OF ANY EXPRESS OR IMPLIED WARRANTY ON THIS PRODUCT. EXCEPT TO THE EXTENT PROHIBITED BY APPLICABLE LAW, ANY IMPLIED WARRANTY OF MERCHANTABILITY OR FITNESS FOR A PARTICULAR PURPOSE ON THIS PRODUCT IS LIMITED IN DURATION TO THE DURATION OF THIS WARRANTY.**

**PLEASE NOTE: GE IS NOT RESPONSIBLE FOR CONSEQUENTIAL, INCIDENTAL, OR SPECIAL DAMAGES ARISING FROM DEFECTS IN THE MONOGRAM WINE VAULT OR CELLAR MANAGEMENT SOFTWARE (WHETHER ARISING FROM THEIR MANUFACTURE, DESIGN, DELIVERY OR INSTALLATION), AND INCLUDING, BY WAY OF EXAMPLE AND NOT LIMITATION, CLAIMS OR DAMAGES ARISING FROM WINE SPOILAGE, SPILLAGE, BREAKAGE OR RUINATION OF ANY KIND.**

## What Is and Is Not Covered for Software

### LIMITED WINE INVENTORY SOFTWARE AND STORAGE DEVICE WARRANTY

Limited Software Warranty. GE will provide remote technical support (online or telephone support at our option) for any GE-supplied software for the period of one year from the date of purchase.

GE warrants only that the software shall perform in accordance with the written support materials supplied by GE with such software. GE's sole and exclusive obligation for breach of the foregoing warranty shall be to provide the error correction on a timely basis. The foregoing warranty does not cover nonconformance due to (a) any modification, reconfiguration, or maintenance of the software performed by any other party than GE; (b) any use of the software on a system that does not meet GE's minimum standards for such software; or (c) any hardware or non-GE software. GE does not warrant that operation of the software will be uninterrupted, secure, or error-free or that all errors will be corrected. GE further does not warrant that the information stored or transmitted by the software is free from unauthorized modification.

Limited Storage Device Warranty. If the storage device (such as flash drive) on which the backup data is stored is defective, GE will replace the device upon your written request to GE, including a dated receipt or packing slip. A replacement device will be mailed to You within 60 days of GE's receipt of Your request. You may be required to return the defective device at GE's expense to an address to be provided.

**Disclaimer of Software Warranties. EXCEPT AS EXPRESSLY PROVIDED ABOVE, THE SOFTWARE AND SERVICES ARE PROVIDED "AS-IS" AND, TO THE MAXIMUM EXTENT PERMITTED BY APPLICABLE LAW, GE, ITS AFFILIATES, LICENSORS, PARTICIPATING FINANCIAL INSTITUTIONS, THIRD-PARTY SOFTWARE, CONTENT OR SERVICE PROVIDERS, DISTRIBUTORS, DEALERS, REPRESENTATIVES AND AGENTS (COLLECTIVELY, "REPRESENTATIVES") DISCLAIM ALL WARRANTIES, EXPRESS OR IMPLIED, REGARDING THE SOFTWARE OR SERVICES, DISK AND RELATED MATERIALS, INCLUDING ANY WARRANTY OF FITNESS FOR A PARTICULAR PURPOSE, TITLE, MERCHANTABILITY, AND NON-INFRINGEMENT. GE DOES NOT WARRANT THAT THE SOFTWARE OR SERVICES ARE SECURE, FREE FROM BUGS, VIRUSES, INTERRUPTION, ERRORS, OR OTHER PROGRAM LIMITATIONS. SOME STATES DO NOT ALLOW THE EXCLUSION OF IMPLIED WARRANTIES, SO THE ABOVE EXCLUSIONS MAY NOT APPLY TO YOU. IN THAT EVENT, ANY IMPLIED WARRANTIES ARE LIMITED IN DURATION TO 60 DAYS FROM THE DATE OF PURCHASE OR DELIVERY OF THE SOFTWARE, AS APPLICABLE. HOWEVER, SOME STATES DO NOT ALLOW LIMITATIONS ON HOW LONG AN IMPLIED WARRANTY LASTS, SO THE ABOVE LIMITATION MAY NOT APPLY TO YOU. THIS WARRANTY GIVES YOU SPECIFIC LEGAL RIGHTS, AND YOU MAY HAVE OTHER RIGHTS THAT VARY FROM STATE TO STATE.**

All warranties or guarantees given or made by GE with respect to the Software or technical support (1) are only for the benefit of the registered user of the Software or their legally designated successor-in-interest, (2) shall be null and void if a registered user breaches any terms or conditions of this warranty, and (3) may be modified with respect to subsequent Software upgrades or modifications. You will be notified of any such warranty changes via the Internet as soon as feasible; if you are not Internet-connected, your notification may be delayed.

## Important Notice For Both Product and Software Warranties

SOME STATES DO NOT ALLOW THE EXCLUSION OR LIMITATION OF INCIDENTAL OR CONSEQUENTIAL DAMAGES, OR ALLOW LIMITATIONS ON HOW LONG AN IMPLIED WARRANTY LASTS, SO THE ABOVE LIMITATIONS OR EXCLUSIONS MAY NOT APPLY TO YOU. THIS WARRANTY GIVES YOU SPECIFIC LEGAL RIGHTS, AND YOU MAY HAVE OTHER RIGHTS, WHICH VARY FROM STATE TO STATE. TO KNOW WHAT YOUR LEGAL RIGHTS ARE IN YOUR STATE/PROVINCE, CONSULT YOUR LOCAL/STATE/PROVINCIAL AUTHORITIES.



**GE Consumer & Industrial**  
Appliances  
General Electric Company  
Louisville, KY 40225  
ge.com

# APPENDIX-VINOLOGY

The following terms are commonly used in the wine industry and are also referenced within this guidebook.

## Wine Terms

| Term               | Definition  |
|--------------------|---|
| <b>APPELLATION</b> | The Appellation of Origin refers to the region in a country where the majority of grapes used in a wine are grown.  |
| <b>DESIGNATION</b> | Refers to the vineyard producing the grapes or a unique producer label.   |
| <b>DRINK/HOLD</b>  | A maturity status assigned to bottles which may be consumed now but will improve with more aging.   |
| <b>DRINK</b>       | A maturity status assigned to bottles which are in peak form and should be consumed now for best results.   |
| <b>HOLD</b>        | A maturity status assigned to bottles which should be allowed to mature to reach their full potential.  |
| <b>IN DECLINE</b>  | A maturity status assigned to bottles which have already passed their peak but may still retain some value.   |
| <b>PAST</b>        | A maturity status assigned to bottles which may not be drinkable due to loss of quality.  |
| <b>VARIETAL</b>    | Refers to the type of wine and is derived from the grape or vine type a wine is made from, such as Cabernet Sauvignon or Pinot Noir.                              |
| <b>VINTAGE</b>     | The vintage date indicates the year the grapes used to make the wine are harvested. Nonvintage wines are made from blends of grapes harvested in different years. |

## Bottle Sizes

The chart below describes the most common bottle types and sizes used for wine. Individual regions may have additional sizes and names unique to that region.

| Capacity             | Name                            | Description  |
|----------------------|---------------------------------|--|
| 375 ml               | <b>"Dessert Wine"</b>           | Contains one-half a standard 750 ml bottle.  |
| 750 ml               | <b>Bottle</b> or <b>"Fifth"</b> | Standard bottle size.  |
| 750 ml or 1.5 liters | <b>Champagne</b>                | Most common sizes for Champagne.   |
| 1.5 liters           | <b>Magnum</b>                   | Contains the equivalent to 2 bottles of wine.  |
| 3 liters             | <b>Double Magnum</b>            | Contains the equivalent to 4 bottles of wine and is twice as large as the magnum.  |
| 3 or 4.5 liters      | <b>Jeroboam</b>                 | Contains 3 liters (4 bottles) in Champagne and Burgundy and 4.5 liters (6 bottles) in Bordeaux.  |
| 4.5 liters           | <b>Rehoboam</b>                 | Contains the equivalent to 6 bottles of wine and is used in Burgundy and Champagne. For Bordeaux, see Jeroboam.  |
| 6 liters             | <b>Imperial</b>                 | Contains the equivalent to 8 bottles of wine and is usually used for Bordeaux and for Cabernet Sauvignon. In Burgundy and Champagne, this size is called a Methuselah. |
| 6 liters             | <b>Methuselah</b>               | Contains the equivalent to 8 bottles of wine. French champagne bottled in a Methuselah is expected to age for a long time.   |
| 9 liters             | <b>Salmanazar</b>               | Contains the equivalent to 12 bottles or a case of wine.   |
| 15 liters            | <b>Nebuchadnezzar</b>           | Contains the equivalent to 20 bottles and is the largest wine container. Found most often in Burgundy and Champagne.   |

# APPENDIX—THE PERFECT SERVE

Serving up a fine wine is an art form unto itself. To maximize your artistic flair, the following tips can help turn every wine into a masterpiece of the palate.

## Choosing the Perfect Glass

### The Right Glass for the Right Wine

While the variety of wine glass styles is almost as extensive as the number of different wine varieties, there are four primary styles that are a must for wine aficionados:

**Red wine** glasses are taller and wider, allowing you to better appreciate the complexities of the wine. There are two primary styles of red wine glasses.

The **Bordeaux** glass is designed for rich, full-bodied red wines, such as Cabernets and Merlots, and features a wide bowl that allows the wine to breathe and brings out the rich aromas. The tall bowl lets the wine proceed directly to the back of the mouth, allowing for maximum flavor.

A **Burgundy** glass is recommended for other full-bodied wines, such as a Pinot Noir. Larger than the Bordeaux glass, the Burgundy glass features a large bowl that allows the wine to dispense to the tip of the tongue, making it easier to taste the sweetness of the wine.

**White wine** glasses are smaller to help keep the wine cool. A **young, crisp white** wine should be served in a glass with an opening that's slightly larger than the body of the glass itself. This allows the wine to dispense at the tip and sides of the tongue, bringing out the wine's sweetness.

For more **mature white** wines, you will want a taller, straighter glass. This type of glass will allow the wine to dispense to the rear and sides of the tongue, allowing you to better taste the bolder flavor.

## The 20/20 Rule

### 20/20 Rule of Thumb for Serving Temperatures

Your wine vault is designed to maintain an optimal wine storage temperature of 55°F for both red and white wines. To allow the wine to arrive at approximate serving temperature, use the 20/20 rule of thumb.

When serving **red** wines, remove the bottle 20 minutes before serving and place on the table. At the end of 20 minutes, a bottle of red wine should reach just below average room temperature.

When serving **white** wines, remove the bottle 20 minutes before serving and place in a bucket of ice and water. This should chill the white wine down to the mid-40°F range.



# Ideal Serving Temperatures

The Monogram® Wine Vault is designed to store wine at the proper long-term storage temperature of 55°F. Storage temperatures and serving temperatures can be quite different. The temperature ranges shown below are the suggested serving temperatures. Individual preferences may vary.

As a rule for both red and white wines, colder temperatures minimize and mellow the wine's flavor and bouquet. Warmer temperatures allow wines to open up and present a bolder flavor and aroma.

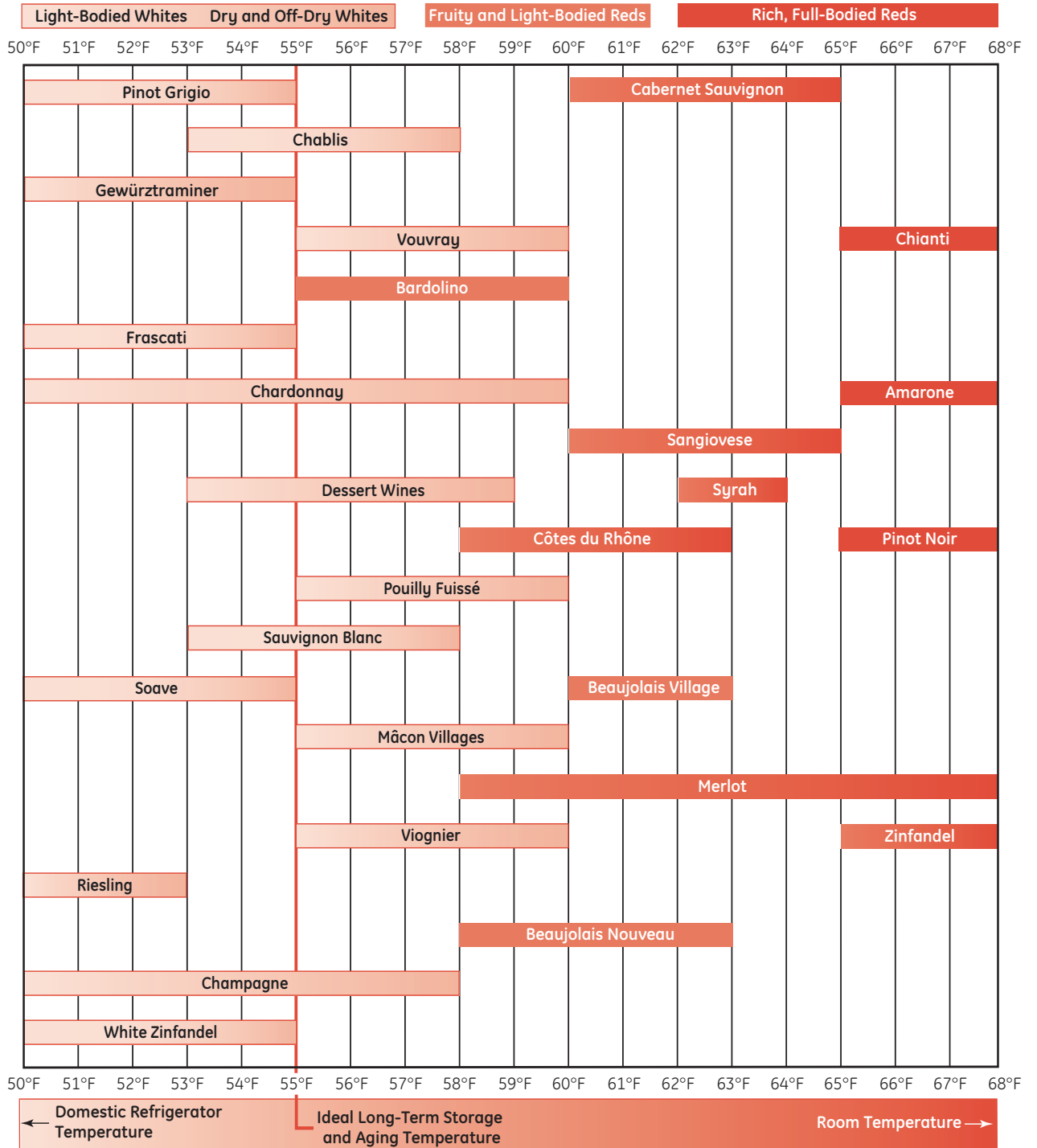

Table information courtesy of Brown-Forman.



**GE Consumer & Industrial**  
Appliances  
General Electric Company  
Louisville, KY 40225  
ge.com

**Models:**

**ZWVS1000SR, Storage Racking System**  
**ZWVT1000SR, Tasting Racking System**

**49-60373-1**

**197D6634P001**  
**12-06 JR**